

heatmiser®



Model: TM4 **V2**





Table of Contents

Product Image	1
Table of Contents	2
Installation Procedure	3-4
LCD Display	5-6
Normal Run Mode	7
Setting the Clock	8
Holiday	9
Selecting 5/2 Day or 7 Day Programming	10
Adjusting the Switching Times	11
Copy Function	12
Mode Select	13
Boost Facility	13
Wiring Diagram	14



Installation Procedure



Do

Mount the time clock at eye level.

Read the instructions fully so you get the best from our product..



Don't

Do not install near to a direct heat source as this will affect functionality.

Do not push hard on the LCD screen as this may cause irreparable damage.

This time clock is designed to be flush mounted and requires a back box of 35mm (minimum depth) to be sunk into the wall prior to installation.

Step 1

Carefully separate the front half of the time clock from the back plate by placing a small flat head terminal driver into the slots on the bottom face of the time clock.

Step 2

Place the front of the time clock somewhere safe.

Terminate the time clock as shown on the wiring diagram on page 14 of this booklet.

Step 3

Screw the time clock back plate securely into the back box.

Step 4

Clip the front of the time clock on to the back plate.

1



2



3



4



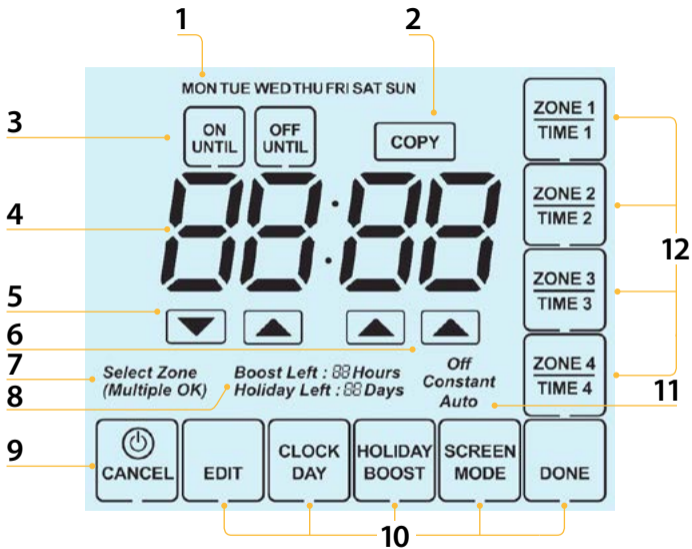

1. Day Indicator - Displays the day.
2. Copy - Enables copying of switching times from one zone to another.
3. On Until/Off Until - Displays the current operational status of the timed output.
4. Timer Status - Displays the current status of the timed output.
5. Up/Down Keys - Increase or decrease values shown on left digit group.
6. Up/Down Keys - Increase or decrease values shown on right digit group.
7. Select Zone - Prompts a zone selection.
8. Boost Left/Holiday Left - Displays the remaining duration of a timed boost or holiday setting.
9. Power: Press once to turn off display. Cancel: Used to exit setup/program operations.
10. Setup/Programming Keys - Used to navigate setup options.
11. Off/Constant/Auto - Displays selected zones' programming mode.
12. Zone/Time Selection Keys - Used with Zone/Times configuration.

M Normal Run Mode

In normal run mode, the time clock will display the current time. It can also be set to show the status for a particular zone. To display the status of a zone, press Zone 1 – Zone 4. This screen will be displayed until you press DONE and return to the main menu.



Normal Run Mode







Zone Selected



Setting the Clock

To set the clock, follow these steps:

- Press the Clock key 
- Use the Left Up/Down keys to set the hour 
- Use the Right Up/Down arrow keys to set the minute 
- Press the Day key to set the day 
- Press DONE to confirm and exit 

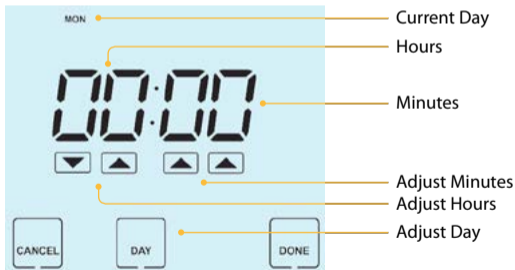







Holiday

All four timed outputs will be disabled during a holiday period.

At the end of your holiday, the time clock will revert back to the programmed setting.

- Press HOLIDAY 
- Enter the desired duration in days  
- Press DONE to confirm and exit 



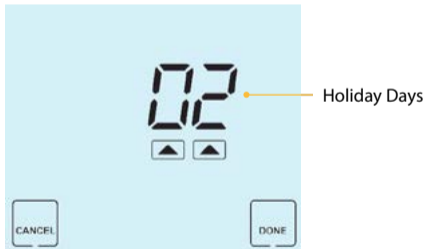

Note: A holiday period does not start until 00:00 the next day. For example, if you set a holiday period on Friday for 2 days, Saturday will be counted as the first day and the time clock will revert back to the programmed schedule at 00:00 on Monday.



To cancel a Holiday setting, reduce the holiday time to 00 days.

5/2 Selecting 5/2 Day or 7 Day Programming

Each zone can be programmed to work in 5/2 (Weekday/Weekend) or 7 Day mode.

- Press ZONE 1 
- Press Day 
- Use the Up/Down arrow keys to set the programming mode  
00 = 5/2 Day mode, 01 = 7 Day mode
- Press DONE to confirm and exit 

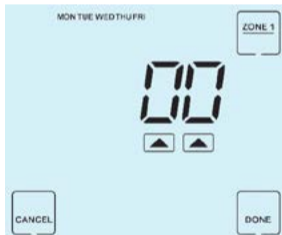

In 5/2 Day mode the time clock will display Mon > Fri prompting you to program the switching times for the weekend.

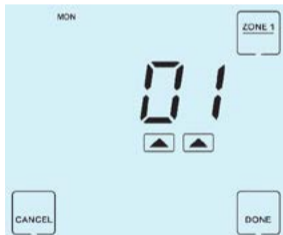

In 7 Day mode, the time clock will display Mon.



Adjusting the Switching Times

Each zone has 4 On/Off times. To program the switching time, follow these steps:

- Select the zone you wish to program, for example Zone 1
- Press EDIT
If the zone is operating in 5/2 day mode, you will see Mon, Tue, Wed, Thu, Fri on the display. If it is operating in 7 day mode, you will see Mon.
- Press the Day key to select the day to program
- Use the Up/Down arrow keys to set the on time
- Press the OFF key to program the off time
- Use the Up/Down arrow keys to set the off time
- Repeat for Time 2, 3 and 4
- Press DONE to confirm and exit



Copy Function

The Time clock has a copy function, enabling you to copy switching times from one zone to another. To use the Copy function, follow these steps:

- Select the zone to copy from and press EDIT
- Press the Copy key
- Select each zone you want to copy to
- Press DONE to confirm and exit

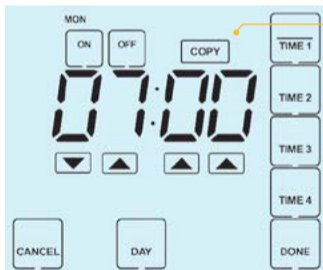

Copy Key

M Mode Select

Each zone can operate in 3 modes: Auto: The zone will work to the programmed switching times. Off: The zone will switch off completely. Constant: The zone will stay on indefinitely.

To set the mode for the zone, follow these steps:

- Select the zone you wish to program
- Press Mode until the desired mode is displayed
- Press DONE to confirm and exit

Boost Facility

Each zone has a boost facility allowing you to turn any of the zones on for a number of hours. This is ideal for when you need to extend the time period but do not wish to reprogram the time clock settings. To use the Boost facility, follow these steps:

- Select the zone
- Press Boost
- Use the Up/Down arrow keys to enter the boost period (in hours)
- Press DONE to confirm and exit

The remaining Boost time will be displayed on-screen.

To cancel the boost early, repeat the steps above reducing the boost time to 00.



Wiring Diagram - TM4

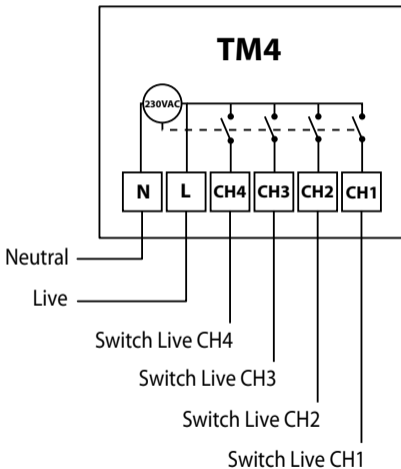



Want More Information?

Call our support team on: +44 (0)1254 669090

Or view technical specifications directly on our website:
www.heatmiser.com



PDF



FAQ

Heatmiser UK Ltd

Units 1-5 Hurstwood Court, Mercer Way
Shadsworth Business Park, Blackburn,
Lancashire, BB1 2QU, United Kingdom.



Twitter: @heatmiseruk



Facebook: facebook.com/thermostats